

Smart choice for power™

**xantrex™**  
A MISSION CRITICAL ELECTRONICS BRAND

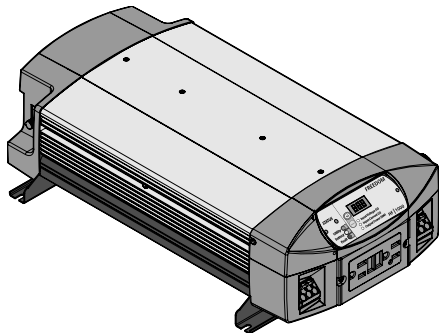

Product image shown may vary from actual product. See features for comparisons.

## Owner's Guide

# Freedom HF Inverter Charger

### Product Model Numbers

806-1020  
806-1055, 806-1054, 806-1054-01  
806-1055-02  
806-1544, 806-1544-01  
806-1840  
806-1840-01, 806-1840-03, 806-1840-04, 806-1840-05  
806-1840-02

---

Copyright © 2014-2021 Xantrex LLC. All Rights Reserved. All trademarks are owned by Xantrex LLC and its affiliates.

### Exclusion for Documentation

UNLESS SPECIFICALLY AGREED TO IN WRITING, SELLER

- (A) MAKES NO WARRANTY AS TO THE ACCURACY, SUFFICIENCY OR SUITABILITY OF ANY TECHNICAL OR OTHER INFORMATION PROVIDED IN ITS MANUALS OR OTHER DOCUMENTATION;  
(B) ASSUMES NO RESPONSIBILITY OR LIABILITY FOR LOSSES, DAMAGES, COSTS OR EXPENSES, WHETHER SPECIAL, DIRECT, INDIRECT, CONSEQUENTIAL OR INCIDENTAL, WHICH MIGHT ARISE OUT OF THE USE OF SUCH INFORMATION. THE USE OF ANY SUCH INFORMATION WILL BE ENTIRELY AT THE USER'S RISK; AND  
(C) REMINDS YOU THAT IF THIS MANUAL IS IN ANY LANGUAGE OTHER THAN ENGLISH, ALTHOUGH STEPS HAVE BEEN TAKEN TO MAINTAIN THE ACCURACY OF THE TRANSLATION, THE ACCURACY CANNOT BE GUARANTEED. APPROVED CONTENT IS CONTAINED WITH THE ENGLISH LANGUAGE VERSION WHICH IS POSTED AT <http://www.xantrex.com/>.

**NOTE:** Visit <http://www.xantrex.com/>, click Products, select a Product category, select a Product, and search the Product Documents panel for a translation of the English guide, if available.

**Document Number:** 975-0390-01-01

Rev J

**Date:** May 2021

### Product Names and Part Numbers

#### 1000-watt Models

Freedom HF 1000 (806-1020)  
Freedom HF 1055 (806-1055, 806-1054, 806-1054-01)  
Freedom HF 1055 EMS (806-1055-02)

#### 1500-watt Models

Freedom HF 1500 (806-1544, 806-1544-01)

#### 1800-watt Models

Freedom HF 1800 (806-1840)  
Freedom HF 1800 T (806-1840-01, 806-1840-03, 806-1840-04, 806-1840-05)  
Freedom HF 1800 EMS (806-1840-02)

### Contact Information

**Telephone:** (Toll Free USA/Canada) +1 800 670 0707 / (Outside USA/Canada) +1 408 987 6030

**Email:** [customerservice@xantrex.com](mailto:customerservice@xantrex.com),  
<http://www.xantrex.com/power-products-support/>

**Web:** <http://www.xantrex.com/>

### Information About Your System

As soon as you open your product, record the following information and be sure to keep your proof of purchase.

Serial Number \_\_\_\_\_  
Product Number \_\_\_\_\_  
Purchased From \_\_\_\_\_  
Purchase Date \_\_\_\_\_

To view, download, or print the latest revision, visit the website shown under **Contact Information**.

# ABOUT THIS GUIDE

## Purpose

The purpose of this Owner's Guide is to provide explanations and procedures for operating, maintaining, and troubleshooting a Freedom HF Inverter Charger for Recreational, Fleet Vehicle, or Marine installations.

## Scope

The guide provides safety guidelines as well as information about operating and troubleshooting the installation the inverter/charger. It also provides information about troubleshooting the unit. It does not provide details about particular brands of batteries. You need to consult individual battery manufacturers for this information.

## Audience

The guide is intended for users and operators of the Freedom HF Inverter Charger.

## Conventions Used

The following conventions are used in this guide.

### **DANGER**

**DANGER** indicates a hazardous situation which, if not avoided, **will result in** death or serious injury.

### **WARNING**

**WARNING** indicates a hazardous situation which, if not avoided, **could result in** death or serious injury.

### **CAUTION**

**CAUTION** indicates a hazardous situation which, if not avoided, **could result in** minor or moderate injury.

### **NOTICE**

**NOTICE** is used to address practices not related to physical injury.

**IMPORTANT:** These notes describe things which are important for you to know, however, they are not as serious as a caution or warning.

---

## Related Information

You can find more information about Xantrex products and services at <http://www.xantrex.com/>.

The Installation Guide (Document Part Number: 975-0395-01-01) is intended for qualified personnel. Qualified personnel have training, knowledge, and experience in:

- Installing electrical equipment and PV power systems (up to 1000 volts).
- Applying all applicable installation codes.
- Analyzing and reducing the hazards involved in performing electrical work.
- Selecting and using Personal Protective Equipment (PPE).

# IMPORTANT SAFETY INSTRUCTIONS

READ AND SAVE THIS OWNER'S GUIDE FOR FUTURE REFERENCE.

This chapter contains important safety instructions for the Freedom HF Inverter/Charger (Freedom HF). Each time, before using the Freedom HF, READ ALL instructions and cautionary markings on or provided with the inverter/charger, the batteries, and all appropriate sections of this guide.

**NOTE:** The Freedom HF contains no user-serviceable parts. See Warranty online for guidance.

## DANGER

### ELECTRIC SHOCK HAZARD

- Do not expose the Freedom HF to rain, snow, spray, or bilge water. This inverter/charger is designed for marine applications only when additional drip protection is installed in certain orientations. See the installation guide for information.
- Do not operate the inverter/charger if it has received a sharp blow, been dropped, has cracks or openings in the enclosure including if the fuse cover has been lost, damaged, or will not close, or otherwise damaged in any other way.
- Do not disassemble the inverter/charger. Internal capacitors remain charged after all power is disconnected.
- Disconnect both AC and DC power from the inverter/charger before attempting any maintenance or cleaning or working on any circuits connected to the inverter/charger. See note below.
- Do not operate the inverter/charger with damaged or substandard wiring. Make sure that all wiring is in good condition and is not undersized.

**Failure to follow these instructions will result in death or serious injury.**

**NOTE:** Turning off the inverter/charger using the on/off switch on the front panel will not reduce an electrical shock hazard.

## DANGER

### FIRE AND BURN HAZARD

- Do not cover or obstruct the air intake vent openings and/or install in a zero-clearance compartment.
- Do not use transformerless battery chargers in conjunction with the inverter/charger due to overheating.

**Failure to follow these instructions will result in death or serious injury.**

## DANGER

### EXPLOSION HAZARD

- Charge only properly rated (such as 12 V) lead-acid (GEL, AGM, Flooded, or lead-calcium) rechargeable batteries because other battery types may explode.
- Do not work in the vicinity of lead-acid batteries. Batteries generate explosive gases during normal operation. See note #1.
- Do not install and/or operate in compartments containing flammable materials or in locations that require ignition-protected equipment. See notes #2 and #3.

**Failure to follow these instructions will result in death or serious injury.**

#### NOTES:

1. Follow these instructions and those published by the battery manufacturer and the manufacturer of any equipment you intend to use in the vicinity of the battery. Review cautionary markings on these products and on the engine.
2. This inverter/charger contains components which tend to produce arcs or sparks.
3. Locations include any space containing gasoline-powered machinery, fuel tanks, as well as joints, fittings, or other connections between components of the fuel system.

# Precautions When Working With Batteries

**IMPORTANT:** Battery work and maintenance must be done by qualified personnel knowledgeable about batteries to ensure compliance with battery handling and maintenance safety precautions.

## **WARNING**

### **BURN FROM HIGH SHORT-CIRCUIT CURRENT, FIRE AND EXPLOSION FROM VENTED GASES HAZARDS**

- Always wear proper, non-absorbent gloves, complete eye protection, and clothing protection. Avoid touching your eyes and wiping your forehead while working near batteries. See note #4.
- Remove all personal metal items, like rings, bracelets, and watches when working with batteries. See notes #5 and #6 below.
- Never smoke or allow a spark or flame near the engine or batteries.
- Never charge a frozen battery.

**Failure to follow these instructions can result in death, serious injury, or equipment damage.**

### **NOTES:**

1. Mount and place the Freedom HF Inverter Charger unit away from batteries in a well ventilated compartment.
2. Always have someone within range of your voice or close enough to come to your aid when you work near a lead-acid battery.
3. Always have plenty of fresh water and soap nearby in case battery acid contacts skin, clothing, or eyes.
4. Keep battery terminals clean from corrosion. If battery acid or corrosion deposit contacts skin or clothing, wash immediately with soap and water. If battery acid or corrosion deposit enters your eye, immediately flood it with running cold water for at least twenty minutes and have someone within range of your voice or close enough to get medical attention immediately.
5. Use extra caution to reduce the risk of dropping a metal tool on the battery. It could spark or short circuit the battery or other electrical parts and could cause an explosion. Use tools with insulated handles only.
6. Batteries can produce a short circuit current high enough to weld a ring or metal bracelet or the like to the battery terminal, causing a severe burn.
7. When removing a battery, always remove the negative terminal from the battery first for systems with grounded negative. If it is grounded positive, remove the positive terminal first. Make sure all loads connected to the battery and all accessories are off so you don't cause an arc.

## Precautions When Preparing to Charge

### **WARNING**

#### **EXPOSURE TO CHEMICALS AND GASES HAZARD**

- Make sure the area around the battery is well ventilated.
- Make sure the voltage of the batteries matches the output voltage of the inverter/charger.
- Be careful to keep corrosion from coming into contact with your eyes and skin when cleaning battery terminals.

**Failure to follow these instructions can result in death or serious injury.**

#### **NOTES:**

- Study and follow all of the battery manufacturer's specific precautions, such as removing or not removing cell caps while charging, whether equalization is acceptable for your battery, and recommended rates of charge.
- For flooded non-sealed batteries, add distilled water in each cell until battery acid reaches the level specified by the battery manufacturer. This helps to purge excessive gas from cells. Do not overfill. For a battery without removable cell caps, carefully follow manufacturer's instructions.

## Precautions When Placing the Unit

### **WARNING**

#### **FIRE HAZARD**

Do not install the inverter/charger or any part of its supplied wiring in engine compartments.

**Failure to follow these instructions can result in death or serious injury.**

### **NOTICE**

#### **RISK OF INVERTER/CHARGER DAMAGE**

- Never allow battery acid to drip on the inverter/charger when reading specific gravity, or filling battery.
- Never place the Freedom HF unit directly above batteries; gases from a battery will corrode and damage the inverter/charger.
- Do not place a battery on top of the inverter/charger.

**Failure to follow these instructions can result in equipment damage.**



# Precautions When Using Rechargeable Appliances

## NOTICE

### RISK OF INVERTER/CHARGER DAMAGE

Most rechargeable battery-operated equipment uses a separate charger or transformer that is plugged into an AC receptacle and produces a low voltage charging output.

Some chargers for small rechargeable batteries can be damaged if connected to the Freedom HF. Avoid using the following with the Freedom HF:

- Small battery-operated appliances like flashlights, razors, and night lights that can be plugged directly into an AC receptacle to recharge.
- Some chargers for battery packs used in power hand tools. These affected chargers display a warning label stating that dangerous voltages are present at the battery terminals.

If you are unsure about using your rechargeable appliance with the Freedom HF, contact the equipment manufacturer to find out if the appliance is acceptable for use with an inverter that has a modified sine wave output voltage.

**Failure to follow these instructions can result in equipment damage.**

## Regulatory

The Freedom HF Inverter/Charger is certified to appropriate US and Canadian standards. For more information see *Regulatory Approvals on page 56*.

The Freedom HF Inverter/Charger is intended to be used for mobile or commercial applications. This inverter/charger is designed for marine applications only when additional drip protection is installed in certain orientations. See the installation guide for information.

It is not intended for other applications as it may not comply with the additional safety code requirements needed for those other applications. See "Limitations On Use" below.

## WARNING

### LIMITATIONS ON USE

Do not use in connection with life support systems.

**Failure to follow these instructions can result in death or serious injury.**

**NOTE:** The Freedom HF Inverter/Charger is a modified sine wave inverter/charger. Please ensure your equipment or devices are compatible with modified sine wave prior to usage.

## FCC Information to the User

This equipment has been tested and found to comply with the limits for a Class B digital device, pursuant to part 15 of the FCC Rules.

These limits are designed to provide reasonable protection against harmful interference in a residential installation. This equipment generates, uses, and can radiate radio frequency energy and, if not installed and used in accordance with the instructions, may cause harmful interference to radio communications.

However, there is no guarantee that interference will not occur in a particular installation. If this equipment does cause harmful interference to radio or television reception, which can be determined by turning the equipment off and on, the user is encouraged to try to correct the interference by one or more of the following measures:

- Reorient or relocate the receiving antenna.
- Increase the separation between the equipment and receiver.
- Connect the equipment into an outlet on a circuit different from that to which the receiver is connected.
- Consult the dealer or an experienced radio/TV technician for help.

### CAUTION

Unauthorized changes or modifications to the equipment could void the user's authority to operate the equipment.

## KKK Information to the User

The Freedom HF 1055 EMS and Freedom HF 1800 EMS models are marked "KKK-A-1822D Ready". These models are marketed for use in ambulances and emergency vehicle applications. For information of compliance of the ambulance as a whole, please refer to specifications as laid out in Federal Specification for the Star-of-Life Ambulance also known as KKK-A-1822.

# CONTENTS

Important Safety Instructions .....	5	Operation .....	23
Precautions When Working With Batteries .....	7	Configuration .....	24
Precautions When Preparing to Charge .....	8	Setting Battery Types on the Main Unit .....	24
Precautions When Placing the Unit .....	8	Viewing Inverter/Charger Information .....	25
Precautions When Using Rechargeable Appliances .....	9	Adjusting Feature Settings .....	26
Regulatory .....	9	Display Panel Operation .....	29
FCC Information to the User .....	10	Operating in Shore Power Mode .....	30
KKK Information to the User .....	10	Operating in Inverter Mode .....	31
Introduction .....	13	Inverter Mode Setting is ON (“Standby”) .....	31
Materials List .....	13	Turning the Inverter Function On and Off .....	31
Key Features .....	14	Inverter Mode Setting is OFF .....	32
Features .....	16	Energy Saver 25-hour Automatic Shut Off .....	32
Front Panel .....	17	Status LED During Inverter Mode .....	32
Rear Panel .....	20	Checking Battery Status .....	33
Display Panel .....	21	Checking Output Power .....	33
Remote and Power Module Panel .....	21	Operating During Transition Between Shore Power and Inverter Mode .....	34
Side Panel .....	22		
Remote Display Panel .....	22		

---

Transitioning from Shore Power to Inverter Mode .....	34
Transitioning from Inverter Mode to Shore Power .....	34
Operating Limits .....	35
Inverter Loads .....	36
Battery Charging .....	38
Routine Maintenance .....	40
Inverter Overload Operation .....	41
Invert Power Derating vs. Ambient Temperature .....	41
<b>Troubleshooting .....</b>	<b>43</b>
Common Problems .....	44
Buzz in Audio Equipment .....	44
Television Reception .....	44
Warning Messages .....	45
Troubleshooting Reference .....	49
Inverter Applications .....	53
Resistive Loads .....	53
Motor Loads .....	53
<b>Specifications .....</b>	<b>54</b>

# 1 INTRODUCTION

The Freedom HF Inverter Charger is designed with integrated inverting and charging functions and power management features suitable for marine, recreational, and commercial/fleet vehicle installations.

Please read this section to familiarize yourself with the main performance and protection features of the Freedom HF.

## Materials List

The Freedom HF (PN: 806-1020 | 806-1840) base package includes the following items:

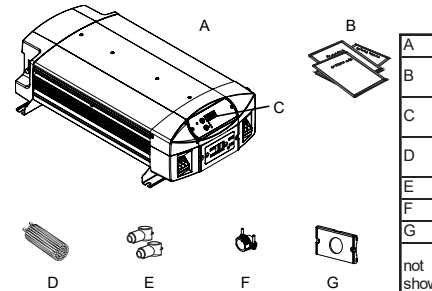

A	one Freedom HF unit
B	one set of owner's and installation guides and a mounting template
C	one display panel with 7-inch (0.17 m) cable
D	one communications cable (25 feet) (7.5 m)
E	two DC terminal covers
F	one strain-relief clamp
G	one GFCI cover plate with knockout
not shown	one display panel blanking plate
	one display panel mounting bezel
	one set of lock washers and nuts

*Figure 1 What's In The Box*

**NOTE:** If any of the items are missing, contact Xantrex or any authorized Xantrex dealer for replacement. See *Contact Information* on page 2.

Other Freedom HF OEM (original equipment manufacturer) models may include other DC and/or AC connectors.

# Key Features

## Power for Most Appliances

The Freedom HF inverter/charger provides up to:

- 1000 watts<sup>a</sup>
- 1500 watts<sup>b</sup>
- 1800 watts<sup>c</sup>

of continuous modified sine wave power derived from a battery bank. It is designed to handle loads such as microwave ovens, TVs, VCRs, and mid-sized power tools. In addition, the Freedom HF's high-surge capability lets you handle many hard-to-start loads, including large TVs and small refrigerators.

The built-in transfer switch automatically transfers between inverter power and shore power from recreational facilities such as boat docks or campsites to ensure power is always available. The built-in charger also automatically charges the battery bank when the Freedom HF is connected to shore power.

## Back-up Capability

If incoming shore power is interrupted by external events like brownouts, the Freedom HF automatically becomes an independent power source<sup>d</sup> that supplies quality AC to your loads.

## Comprehensive Protection

The Freedom HF's built-in protection features safeguard your batteries and equipment, such as:

- The low battery voltage alarm and shutdown prevents your batteries from becoming completely discharged,
- the three-stage charging capability ensures that batteries receive efficient charge, and
- automatic switching between inverter power to pass-through shore power.

## Low Power Consumption

When the Freedom HF is inverting without a load, it draws less than 1 amp of current from the battery (or battery bank). This feature allows the unit to operate without draining too much stored energy.

## Overload Alarm and Shutdown

During inverter mode, the Freedom HF automatically alerts you if the loads that are connected and drawing power from the unit are close to approaching the maximum operating limit. If so, the Freedom HF automatically shuts down when the maximum operating limit is exceeded.

## Over temperature Alarm and Shutdown

During inverter mode, the Freedom HF automatically alerts you if it is overheating and approaching the over-temperature shutdown limit. The Freedom HF automatically shuts down when the limit is exceeded.

<sup>a</sup>Freedom HF 1000 (PN: 806-1020), Freedom HF 1055 (PNs: 806-1055, 806-1054, 806-1054-01), and Freedom HF 1055 EMS (PN: 806-1055-02).

<sup>b</sup>Freedom HF 1500 (PN: 806-1544).

<sup>c</sup>Freedom HF 1800 (PN: 806-1840), Freedom HF 1800 T (PN: 806-1840-01, 806-1840-03, 806-1840-04), and Freedom HF 1800 EMS (PN: 806-1840-02).

<sup>d</sup>Assuming the inverter/charger is connected to a battery source with an adequate charge at the time of the power interruption.

**Selectable Low Battery Shutdown** The low battery shutdown for the inverter can be manually selected by the user by choosing a low, middle, or high setting. The low setting default for low battery shutdown is 10.5 volts except Freedom HF 1500 (PN: 806-1544).

Model	PN	Shutdown Settings (V)		
		Low	Mid	High
Freedom HF 1000	806-1020	10.5	n/a	11.8
Freedom HF 1055	806-1054	10.5	n/a	11.8
	806-1054-01	10.5	n/a	11.8
	806-1055	10.5	n/a	11.8
Freedom HF 1055 EMS	806-1055-02	10.5	n/a	11.8
Freedom HF 1500	806-1544, 806-1544-01	12.1	12.1	12.1
Freedom HF 1800	806-1840	10.5	n/a	11.8
Freedom HF 1800 T	806-1840-01, 806-1840-04	10.5	11.8	11.8
	806-1840-03	12.1	12.1	12.1
	806-1840-05	11.8	12.1	12.1
	some 806-1840-01	10.5	n/a	11.8
Freedom HF 1800 EMS	806-1840-02	10.5	n/a	11.8

### Battery-friendly Charging

For the inverter to perform effectively, the batteries must be charged correctly. The Freedom HF has a built-in three-stage charging system that extends the life and optimizes the performance of the batteries. In addition to the numerous features which let you maximize your battery's life and performance, the Freedom HF—unlike many chargers—also has the ability to recharge a near-zero voltage<sup>e</sup> battery and an ignition-switched 20-amp auxiliary 12-volt power source<sup>f</sup>.

### Ignition Control

The Freedom HF features the ability to inhibit the inverter from operating in the absence of a voltage signal from a vehicle's ignition circuit. This is particularly useful if the inverter is required to operate only when a vehicle's engine is running.

<sup>e</sup>Near-zero or dead batteries can be recharged. However, some batteries which have been left uncharged for days can become severely damaged thus, recharging is futile.

<sup>f</sup>Available on the Freedom HF 1055 EMS model and Freedom HF 1800 EMS model. The inverter/charger features a 20-amp fused and switched output voltage supplied from the inverter/charger's positive terminal. When connected to a vehicle's ignition signal, a switched positive voltage is available to power auxiliary circuits that are required to operate only when the vehicle is operational.

## 2 FEATURES

This section identifies the default settings and the hardware features of the Freedom HF Inverter Charger.

*Table 1* lists the default settings for the Freedom HF system.

You may record your settings in the right-hand column after you have configured the Freedom HF.

*Table 1 Freedom HF Default Values*

<b>Item</b>	<b>Default Setting</b>	<b>Your Setting</b>
Alarm*	ON	
Charger Current*	20 A (Freedom HF 1000 model)	
	55 A (Freedom HF 1055 models)	
	40 A (Freedom HF 1500 models)	
	40 A (Freedom HF 1800 models)	
Battery Type**	Flooded(14.4/13.5)	
* adjustable from the display panel.		
** adjustable from the main unit behind the display panel assembly.		



# Front Panel

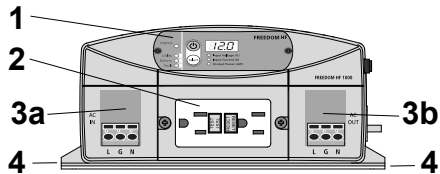

Figure 2 Front Panel (Freedom HF 1000, 1055, 1500, 1800)

Item	Description
1	<b>Display panel</b> displays inverter status and battery status information on the screen. The panel can be detached to expose the dip switches behind it and to extend and mount the panel on a wall or other location.
2	<b>GFCI receptacles</b> during inverter mode provide 1000 watts (Freedom HF 1000, 1055) or 1500 watts (Freedom HF 1500) or 1800 watts (Freedom HF 1800) of power to operate AC devices.
3	<b>WAGO<sup>a</sup> AC terminals</b> for connecting AC input (3a) and AC output (3b) wiring.
4	<b>Mounting flange</b> allows you to mount the inverter permanently.

<sup>a</sup>WAGO® manufactures connection devices such as terminal blocks and related accessories. Freedom HF models indicated above use WAGO terminal blocks as AC input and output connections.



Figure 3 Front Panel (Freedom HF 1800 T)

Item	Description
1	<b>Display panel</b> displays inverter status and battery status information on the screen. The panel can be detached to expose the dip switches behind it and to extend and mount the panel on a wall or other location.
2	<b>GFCI receptacles</b> provide 1800 watts of power to operate AC devices. The GFCI unit can be detached and reinstalled to a separate location. Replace the GFCI unit with the GFCI blanking plate with knockout. The GFCI unit is also removed to access the AC wiring compartment for hard wiring the inverter to an existing AC power system.
3 (for 806-1840-01)	(3a) <b>Male PTI<sup>b</sup> Connector</b> for plugging in a compatible AC Input cordset cable with a female PTI plug. (3b) <b>Female PTI Connector</b> for plugging in a compatible AC Output cordset cable with a male PTI plug.

<sup>b</sup>The electrical cables with PTI connectors (manufactured by Phillips & Temro Industries) referred to in this manual are custom cables that are available for the trucking industry. For Freedom HF 1800 T (806-1840-01), use a 15A PTI custom cable with connector. For Freedom HF 1800 T (806-1840-03, 806-1840-05), use a 20A PTI custom cable with connector.

## Front Panel

Item	Description
3 (for 806-1840-03)	(3a) <b>Female PTI Connector<sup>b</sup></b> for plugging in a compatible AC Output cordset cable with a male PTI plug. (3b) <b>Male PTI Connector</b> for plugging in a compatible AC Input cordset cable with a female PTI plug.
4	<b>Mounting flange</b> allows you to mount the inverter permanently.

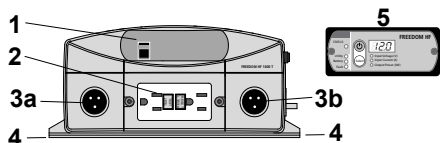

Figure 4 Front Panel (Freedom HF 1800 T)

Item	Description
1	<b>RJ12 with cover plate</b> contains the RJ12 port for the remote panel.
2	<b>GFCI receptacles</b> provide 1800 watts of power to operate AC devices. The GFCI unit can be detached and reinstalled to a separate location. Replace the GFCI unit with the GFCI blanking plate with knockout. The GFCI unit is also removed to access the AC wiring compartment for hard wiring the inverter to an existing AC power system.
3 (for 806-1840-04)	(3a) <b>Male PTI Connector</b> for plugging in a compatible AC Input cordset cable with a female PTI plug. (3b) <b>Female PTI Connector</b> for plugging in a compatible AC Output cordset cable with a male PTI plug.
4	<b>Mounting flange</b> allows you to mount the inverter permanently.
5	<b>Remote panel with bezel</b> contains the display panel which shows inverter status and battery status information on the screen. Mount the remote panel on a wall or other location.
<p><b>NOTE:</b> Freedom HF 1800 T (806-1840-04) comes with the remote panel with bezel and no other spare parts in the package.</p>	

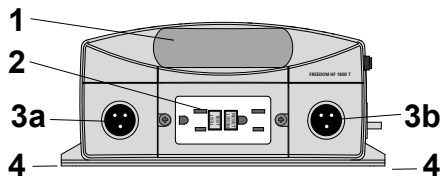

Figure 5 Front Panel (Freedom HF 1800 T)

Item	Description
1	<b>Cover plate.</b>
2	<b>GFCI receptacles</b> provide 1800 watts of power to operate AC devices. The GFCI unit can be detached and reinstalled to a separate location. Replace the GFCI unit with the GFCI blanking plate with knockout. The GFCI unit is also removed to access the AC wiring compartment for hard wiring the inverter to an existing AC power system.
3 (for 806-1840-05)	(3a) <b>Female PTI Connector<sup>b</sup></b> for plugging in a compatible AC Output cordset cable with a male PTI plug. (3b) <b>Male PTI Connector</b> for plugging in a compatible AC Input cordset cable with a female PTI plug.
4	<b>Mounting flange</b> allows you to mount the inverter permanently.

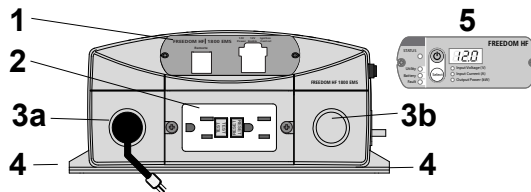

Figure 6 Front Panel (Freedom HF 1055 EMS, 1800 EMS)

Item	Description
1	<b>Power module</b> contains 12-volt DC terminals for ignition controls, an auxiliary power source, and a remote port for attaching the display panel using a communications cable.
2	<b>GFCI unit receptacles</b> provide 1000 watts (1055 EMS) and 1800 watts (1800 EMS) of power to operate AC devices. The GFCI unit can be detached and reinstalled to a separate location. Replace the GFCI unit with the GFCI blanking plate with knockout. The GFCI unit is also removed to access the AC wiring compartment for hard wiring the inverter to an existing AC power system.
3	(3a) 18-inch (0.45m) <b>AC Input electrical cord</b> with 3-prong plug. (3b) Knockout for routing AC output wiring.
4	<b>Mounting flange</b> allows you to mount the inverter permanently.
5	<b>Display panel</b> displays inverter status and battery status information on the screen. Mount the panel on a wall or other location

# Rear Panel

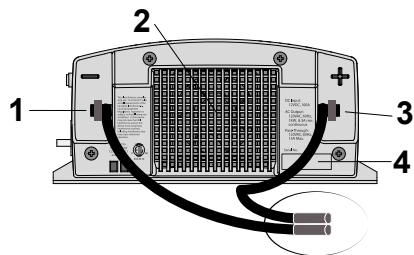

Figure 7 Rear Panel (Freedom HF 1055 EMS, 1800 EMS)

Item	Description
1	<b>Negative DC cabling terminal</b> that is pre-connected to an 18-inch (0.45m) battery cable with an Anderson connector.
2	<b>Ventilation grille</b> (openings) must not be obstructed for the proper operation of the cooling fan and inverter. When the inverter is mounted, the ventilation grille must not point up or down.
3	<b>Positive DC cabling terminal</b> that is pre-connected to an 18-inch (0.45m) battery cable <sup>c</sup> with an Anderson <sup>d</sup> connector.
4	<b>Serial number</b> of your unit.

<sup>c</sup>Freedom HF 1055 EMS has a cable size of 2 AWG with SB175 Anderson connector and 1800 EMS has a cable size of 2/0 AWG with SB350 Anderson connector.

<sup>d</sup>Anderson Power Products® manufactures power interconnects and accessories. An Anderson connector is a term used in this manual to mean a connector manufactured by Anderson Power Products and refers to either SB175 or SB350.

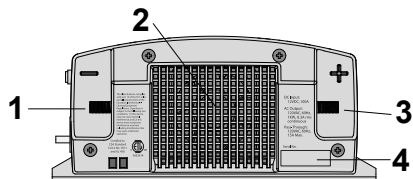

Figure 8 Rear Panel (All Other Models)

Item	Description
1	<b>Negative DC cabling terminal</b> connects to the negative terminal of the battery using a battery cable.
2	<b>Ventilation grille</b> (openings) must not be obstructed for the proper operation of the cooling fan and inverter. When the inverter is mounted, the ventilation grille must not point up or down.
3	<b>Positive DC cabling terminal</b> connects to the positive terminal of the battery using a battery cable.
4	<b>Serial number</b> of your unit.

# Display Panel

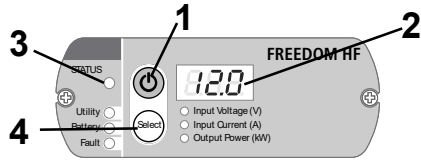

Figure 9 Display Panel (All Models)

Item	Description
1	<b>Inverter Power button</b> is the main unit switch that turns the Freedom HF's inverter function ON or OFF.
2	<b>Three-digit LED display screen</b> shows status information and fault codes.
3	<b>Status LED</b> indicates the mode of operation with a three-color LED.
4	<b>Select button</b> changes status information displayed on the display screen.
<b>IMPORTANT:</b> See <i>Display Panel Operation</i> on page 29 for detailed information on operating the panel's buttons	

# Remote and Power Module Panel

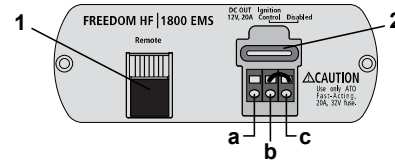

Figure 10 Remote and Power Module Panel (Freedom HF 1055 EMS, 1800 EMS)

Item	Description
1	Remote jack is used for connecting the Display panel that ships with the Freedom HF 1055 EMS and 1800 EMS. Each shipment comes with a 25-foot communications cable as well.
2	Power module has one fuse and three contacts for wires that connect to: <ol style="list-style-type: none"> <li>an auxiliary 12-volt DC OUT terminal,</li> <li>an Ignition Control terminal, and</li> <li>a Disable terminal.</li> </ol> <b>NOTE:</b> The Ignition Control and Disable terminals are connected by a jumper wire that acts to disable ignition control. Removing the jumper wire will enable ignition control.

For instructions on how to enable or disable Ignition Control, see the Installation Guide.

## Side Panel

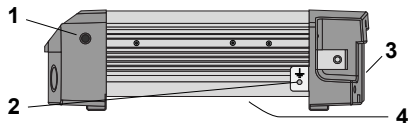

Figure 11 Side Panel

Item	Description
1	<b>15 A supplementary protector</b> provides overload protection for the GFCI receptacles. In a hard wired installation, the supplementary protector does not protect output wiring. However, for models Freedom HF 1055 (PNs: 806-1054, 806-1054-01), Freedom HF 1500 (PN: 806-1544), and Freedom HF 1800 T (PN: 806-1840-01, 806-1840-03, 806-1840-04), the hard-wired AC output connector is protected by both the 15 A supplementary protector and the GFCI.
2	<b>Grounding stud</b> provides a ground path for the Freedom HF chassis to the DC system ground.
3	<b>Main cooling fan</b> turns on when powering loads above 500 watts or when the internal temperature reaches a set point temperature.
4	<b>Auxiliary cooling fan</b> (1800-watt models only) performs the same function as the main cooling fan.

## Remote Display Panel

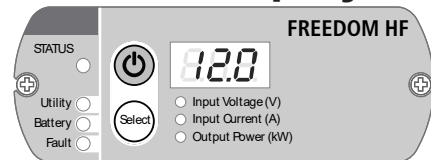

Figure 12 Remote Display Panel

**NOTE:** Not all Freedom HF remote display panels are compatible with different Freedom HF inverter/chargers. Please refer to the compatibility chart below (when ordering an optional or a replacement) to confirm which remote display panel is compatible with your Freedom HF unit.

Model	PN	Remote Display Panel PN
Freedom HF 1000	806-1020	808-1840
Freedom HF 1055	806-1054	
	806-1054-01	
	806-1055	
Freedom HF 1055 EMS	806-1055-02	808-1840
Freedom HF 1500	806-1544, 806-1544-01	808-1544
Freedom HF 1800	806-1840	808-1840
Freedom HF 1800 T	806-1840-01	808-1840-01
	806-1840-04	808-1840-04
	806-1840-03	808-1840-03
	806-1840-05	
Freedom HF 1800 EMS	806-1840-02	808-1840

## 3 OPERATION

This section includes descriptions of the different modes and settings of the Freedom HF Inverter Charger. This section includes:

<b>Configuration</b> .....	<b>24</b>
Setting Battery Types on the Main Unit .....	24
Viewing Inverter/Charger Information .....	25
Adjusting Feature Settings .....	26
<b>Display Panel Operation</b> .....	<b>29</b>
<b>Operating in Shore Power Mode</b> .....	<b>30</b>
<b>Operating in Inverter Mode</b> .....	<b>31</b>
Inverter Mode Setting is ON (“Standby”) .....	31
Turning the Inverter Function On and Off .....	31
Inverter Mode Setting is OFF .....	32
Energy Saver 25-hour Automatic Shut Off .....	32
Status LED During Inverter Mode .....	32
Checking Battery Status .....	33
Checking Output Power .....	33

<b>Operating During Transition Between Shore Power and Inverter Mode</b> .....	<b>34</b>
Transitioning from Shore Power to Inverter Mode .....	34
Transitioning from Inverter Mode to Shore Power .....	34
Operating Limits .....	35
Inverter Loads .....	36
<b>Battery Charging</b> .....	<b>38</b>
Routine Maintenance .....	40
<b>Inverter Overload Operation</b> .....	<b>41</b>
<b>Invert Power Derating vs. Ambient Temperature</b> .....	<b>41</b>

# Configuration

## Setting Battery Types on the Main Unit

You can attach different types of lead-acid batteries to the Freedom HF. Before installing batteries make sure that you configure the unit to optimize the charging process.

The settings can be changed by adjusting the dip switches found on the main unit behind the display panel.

Battery Type	Dip Switch Setting Switch 1 Switch 2	Bulk/Absorption	Float
Fixed	OFF OFF	13.5	13.5
Flooded	OFF ON (default)	14.4	13.5
GEL	ON OFF	14.2	13.8
AGM	ON ON	14.3	13.4

### To adjust the battery type setting:

1. By default the battery type is set to Flooded (OFF|ON) for all models except Freedom HF 1800 T (806-1840-03) which is set to AGM (ON|ON).
2. Detach the Display Panel to expose the Dip Switches.
3. Use the tip of your fingernail or a small screw driver with a flat tip to adjust the switches.

*Figure 13 Dip Switches (Default Settings Shown)*

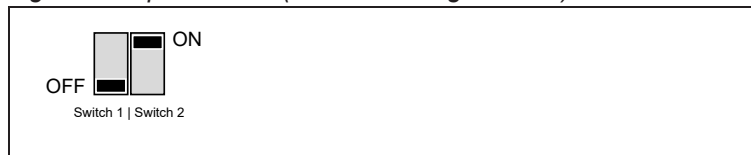



## Viewing Inverter/Charger Information

The LED screen displays inverter/charger information as well as feature settings in coordination with the LED lights underneath the screen.

- Press the Select button to toggle between the following information:

Info and Setting	LED Screen	Info and Settings LED
DC Input Voltage	<i>12.8</i> (example)	Solid – Input Voltage (V)
DC Input Current	<i>11</i> (example)	Solid – Input Current (A)
AC Output Power	<i>0.85</i> (example)	Solid – Output Power (kW)
Charging Current Setting <sup>a</sup>	<i>2A</i> or <i>10A</i> or <i>20A</i>	none
Charging Current Setting <sup>b</sup>	<i>5A</i> or <i>15A</i> or <i>35A</i> or <i>55A</i>	none
Charging Current Setting <sup>c</sup>	<i>2A</i> or <i>10A</i> or <i>20A</i> or <i>40A</i>	none
Inverter Mode Setting	<i>1 n 0</i> or <i>1 n 1</i>	none
Alarm Setting	<i>AL 0</i> or <i>AL 1</i>	none

<sup>a</sup>Settings available only for Freedom HF 1000 (PN: 806-1020).

<sup>b</sup>Settings available only for Freedom HF 1055 (PNs: 806-1054, 806-1054-01, 806-1055, 806-1055-02).

<sup>c</sup>Settings available only for Freedom HF 1500 and 1800 models (PNs: 806-1544, 806-1840, 806-1840-01, 806-1840-02, 806-1840-03, 806-1840-05).

Info and Setting	LED Screen	Info and Settings LED
Low Voltage Setting <sup>d</sup>	<i>5dL</i> or <i>5dn</i> or <i>5dH</i>	none

<sup>d</sup>The middle setting "5dn" is available only for Freedom HF 1500 and 1800 T models (PNs: 806-1544, 806-1840, 806-1840-01, 806-1840-03), 806-1840-05. This setting is not available for some Freedom HF 1800 T (PN: 806-1840-01).

## Adjusting Feature Settings

The Power and Select buttons can be used to:

- change the charging current setting
- change the inverter mode setting
- disable or enable the audible alarm
- change the shutdown setting
- return to factory default settings

Figure 14 Display Panel

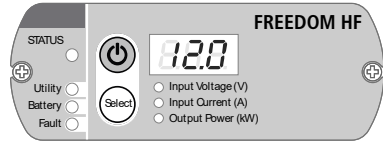

### To cycle through the various feature settings:

1. Press and hold the Inverter Power button for five seconds to enter the feature settings mode.
2. Press the Inverter Power button to toggle between the following information.

Setting	LED Screen
Charging Current Setting	CUr
Inverter Mode Setting	IN0
Alarm Setting	AL
Shutdown Setting	SD
Factory Setting	dEF

### To change the charger's charging current setting:

By default the charging current is set to 20A for Freedom HF 1000, 55A for Freedom HF 1055, and 40A for Freedom HF 1500/1800 models.

1. Press and hold the Inverter Power button for five seconds. The LED screen will flash "CUr" intermittently.
2. Press the Select button once. The LED screen will display the present charging current setting. Example, "40A" for a 40 A setting.
3. Press the Select button again to change to the next setting. The LED screen shows the next setting. Example, "2A" for a 2 A setting.
4. Continue pressing the Select button to cycle through each of the available settings – "2A", "10A", "20A", and "40A", such as in the case of Freedom HF 1800, until you reach the desired setting.
5. Press and hold the Select button for five seconds to make the setting permanent.

Input Circuit Breaker or fuse size (Amps)	Charger DC Current Setting (Amps)		Maximum By-pass AC Current Available (Amps)
	All other models	Freedom HF 1055	
15	2	5	12.5
	5		12.5
	10	15	9.5
	20	35	4.0
	40	55	0
20	2	5	17.5
	5 <sup>a</sup>		17.5
	10	15	14.5
	20	35	9.0
	40 <sup>b</sup>	55	5.0
30	2	5	27.5
	5 <sup>a</sup>		27.5
	10	15	24.5
	20	35	19.0
	40 <sup>b</sup>	55	15.0

a. Available only for the Freedom HF 1000 and 1055 models.

b. Available only for Freedom HF 1500/1800 models.

### To change the inverter mode setting:

By default the inverter mode is set to ON (“i n l”). ON (“i n l”) will put the inverter on standby. This means when shore power is present, AC shore power will pass through as AC output. And when shore power is not available, the inverter function will take power from the battery and provide AC output power. When the inverter mode is ON, you can manually turn the inverter function ON or OFF by using the Inverter Power button. See “Operating in Inverter Mode” on page 17.

OFF (“i n 0”) will completely disable inverter function. This means when shore power is present, AC shore power will still pass through as AC output. However, when shore power is not available, the inverter function remains disabled and therefore no AC output power. When the inverter mode is OFF, you cannot manually turn the inverter function ON or OFF by using the Inverter Power button.

1. Press and hold the Inverter Power button for five seconds.
2. Press the Inverter Power button once. The LED screen will flash “i n” intermittently.
3. Press the Select button once. The LED screen will display the present (or most recent) inverter mode setting. Example, “i n l” for an inverter mode setting of ON or “In0” for an inverter mode setting of OFF.
4. Continue pressing the Select button to cycle through the two settings – “i n l” and “i n 0” until you reach the desired setting.

5. Press and hold the Select button for five seconds to make the setting permanent.

**To adjust the alarm setting:**

By default the alarm is set to ON.

ON (“AL I”) will sound the alarm on all warning and fault conditions.

OFF (“AL 0”) will mute the alarm.

1. Press and hold the Inverter Power button for five seconds.
2. Press the Inverter Power button twice. The LED screen will flash “AL” intermittently.
3. Press the Select button once. The LED screen will display the present (or most recent) alarm setting. Example, “AL I” for an inverter mode setting of ON.
4. Continue pressing the Select button to cycle through the two settings – “AL 0” and “AL I” until you reach the desired setting.
5. Press and hold the Select button for five seconds to make the setting permanent.

**To adjust the low battery shutdown setting:**

By default the low voltage setting is set to Low (“SdL”).

Low (“SdL”) sets the low battery shutdown threshold to 10.5 V for all models except Freedom HF 1500.

Middle (“SdM”) is only available to Freedom HF 1500 and some models of Freedom HF 1800 T. It sets the low battery shutdown threshold to 12.1 V and 11.8 V respectively.

High (“SdH”) sets the low battery shutdown threshold to 11.8 V for all models except Freedom HF 1800 T which sets the low battery shutdown threshold to 12.1 V.

See *Selectable Low Battery Shutdown on page 15* for a summary.

1. Press and hold the Inverter Power button for five seconds.
2. Press the Inverter Power button three times. The LED screen will flash “Sd” intermittently.
3. Press the Select button once. The LED screen will display the present (or most recent) low voltage setting. Example, “SdL” for a low shutdown voltage setting.
4. Continue pressing the Select button to cycle through the two – “SdL” and “SdH” settings (or through three settings<sup>a</sup>) until you reach the desired setting.
5. Press and hold the Select button for five seconds to make the setting permanent.

a. In addition to two settings “SdL” and “SdH”, the middle setting “SdM” is available only for Freedom HF 1500 and 1800 T models (PNs: 806-1544, 806-1840-01, 806-1840-03, 806-1840-04, 806-1840-05, but not some 806-1840-01 which has only “SdL” and “SdH”).

**To return all feature settings to factory default settings:**

1. Press and hold the Inverter Power button for five seconds.
2. Press the Inverter Power button four times. The LED screen will flash “dEF” intermittently.
3. Press and hold the Select button for five seconds to return all feature settings to their factory default settings.

# Display Panel Operation

The Freedom HF features a display panel with three-digit LED display to show inverter, AC source, and battery status information.

Figure 15 Display Panel

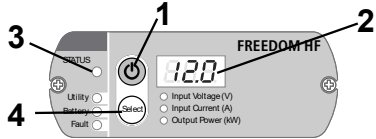

Item	Description
1	<p><b>Inverter Power button</b></p> <ul style="list-style-type: none"> <li>■ Press and hold for one second to turn the Freedom HF’s Inverter function ON or OFF (when AC Shore Power is NOT present.)</li> <li>■ Press and hold for five seconds to adjust feature settings. Go back to <i>Adjusting Feature Settings</i> for instructions.</li> </ul>
2	<p><b>Three-digit LED display screen</b> shows status information and fault codes.</p>

Item	Description
3	<p><b>Status LED</b> Indicates the mode of operation with a three color LED.</p> <p>Green pertains to Utility status.</p> <ul style="list-style-type: none"> <li>■ Solid indicates the Freedom HF is in shore power mode and battery is fully charged.</li> <li>■ Flashing indicates the Freedom HF is in shore power mode and the unit is currently charging the battery.</li> </ul> <p>Yellow pertains to Battery status.</p> <ul style="list-style-type: none"> <li>■ Solid indicates the Freedom HF is in inverter mode and using the battery to provide AC power.</li> <li>■ Flashing indicates the Freedom HF is in inverter mode but AC shore power is detected thus transferring to shore power mode within 20 seconds.</li> </ul> <p>Red indicates a Fault condition and the Freedom HF has shut down. See <i>Troubleshooting Reference on page 49</i>.</p>
4	<p><b>Select button</b></p> <ul style="list-style-type: none"> <li>■ In Inverter mode, press the button to choose what appears in the three-digit LED display: Input Voltage, Input Current, or Output Power. See <i>"To change the inverter mode setting:" on page 27</i>.</li> </ul> <p><b>NOTE:</b> A corresponding LED lights up for each of the three items.</p> <ul style="list-style-type: none"> <li>■ In an Alarm condition, press and hold for two seconds to disable (or enable) the audible alarm. See <i>"To adjust the alarm setting:" on page 28</i>.</li> <li>■ In Charger Current Select Mode, press to select the charger current. See <i>"To change the charger's charging current setting:" on page 26</i>.</li> </ul>

## Operating in Shore Power Mode

The Freedom HF operates in shore power mode when an AC source (a generator or utility power) is present at the AC input terminals. When the AC source is within operating range, the Freedom HF unit bypasses inverter function and powers the appliances connected to the unit. See *Transitioning from Inverter Mode to Shore Power on page 34*.

The Freedom HF also automatically charges the battery bank that is connected while in shore power mode. See *Battery Charging on page 38*.

The Green status LED lights up to indicate that the Freedom HF is using utility (or generator) power and the battery is full. A flashing Green LED indicates that the unit is charging the battery.

When shore power is present, AC power will automatically pass through the Freedom HF. Pressing the Inverter Power button on the display panel will not interrupt the supply of shore power. Shore Power mode supersedes Inverter mode.

When the Freedom HF 's Inverter Power button is turned ON and the AC source is outside the operating range or is disconnected, the transfer switch automatically switches to inverter mode. See *Transitioning from Shore Power to Inverter Mode on page 34*.

## Operating in Inverter Mode

The Freedom HF is in inverter mode when shore power is not presently available and the unit is using the battery (by inverting DC to AC) to power the appliances connected to the Freedom HF.

The Yellow status LED lights up to indicate the Freedom HF is using the battery to power the appliances.

The table on the next page illustrates the battery status during inverter mode as shown on the display panel.

## Inverter Mode Setting is ON (“Standby”)

When the Freedom HF’s Inverter mode setting is turned on (“In”) and the AC source is outside the operating range or is disconnected, the transfer switch automatically switches to inverter function. This means that the AC output terminals will provide power from the battery and any appliance connected to the AC output terminals will operate.

## Turning the Inverter Function On and Off

The Inverter Power button on the display panel turns the Freedom HF’s Inverter function ON and OFF. To operate, press the button and hold for one second.

When shore power is NOT present and Inverter mode is ON:

- the AC outlets will supply power to any attached appliances when the Inverter Power button is turned ON and
- the AC outlets will not supply power to any attached appliances when the Inverter Power button is turned OFF

### **WARNING**

#### **ELECTRICAL SHOCK HAZARD**

Turning the Inverter mode setting to OFF and/or turning the Inverter Power button off do not disconnect DC battery power from the Freedom HF. You must disconnect both AC and DC power before working on any circuits connected to the Freedom HF.

**Failure to follow these instructions can result in death, serious injury, or equipment damage.**

To prevent unnecessary battery discharge, turn the Inverter Power button off when you are not using the Freedom HF.

## Inverter Mode Setting is OFF

When the Freedom HF's Inverter function is turned off ("In") and the AC source is outside the operating range or is disconnected, the Freedom HF will not switch to invert mode. This means that even if the Inverter Power button is pressed to try and turn inverter function on, there will be no power coming from the battery to the AC output terminals. Therefore, any appliance connected to the AC output terminals will not operate.

## Energy Saver 25-hour Automatic Shut Off

During invert mode, a 25-hour countdown is initiated when the AC load drops to less than approximately 80 watts and remains below this level. After 25 hours the inverter automatically shuts off to reduce battery discharge and preserve battery life.

**NOTE:** The feature is available only for Freedom HF 1500 (PN: 806-1544) and Freedom HF 1800 T (PNs: 806-1840-01, 806-1840-03, and 806-1840-04).

## Status LED During Inverter Mode

The following summarizes the behavior of the Status LED during Inverter mode.

*Table 2 Status LED during Inverter Mode*

Status LED	Display Screen	Condition
Solid YELLOW	12.8 (where 12.8 is an example of battery voltage)	Select button is pressed to display Input Battery Voltage. The Input Battery Voltage LED lights up. Value in display screen is shown as Volts.
	11 (where 11 is an example of current)	Select button is pressed to display Input Current. The Input Current LED lights up. Value in display screen is shown as Amps.
	0.85 (where 0.85 is an example of output power in Kilowatts)	Select button is pressed to display Output Power. The Output Power LED lights up. Value in display screen is shown as Kilowatts.
	E05 through E07	Warning condition detected while AC output power is still available. See <i>Error codes displayed on the Display Panel screen on page 46.</i>



Table 2 Status LED during Inverter Mode

Status LED	Display Screen	Condition
Solid RED	E01 through E04	Fault condition detected and AC output power is not available. The unit will sound an alarm and will shutdown completely within 30 seconds <sup>a</sup> . A five-minute delayed shutdown is available in some models <sup>b</sup> . <i>See Error codes displayed on the Display Panel screen on page 46.</i>
Off	OFF	Inverter is OFF.
Off (or Yellow)	00.0	No communication between the Freedom HF and the Display Panel because the battery voltage was too low to start the Inverter.

a. Available in all models except Freedom HF 1500 and 1800 T. See more on page 35.

b. Available only for the Freedom HF 1500 and 1800 T models. See more on page 35.

## Checking Battery Status

During inverter mode, you can check the battery status by pressing the Select button until the Input Voltage LED (or Input Current LED) illuminates. The battery voltage (or battery current) appears in the three-digit LED display screen when the Input Voltage LED (or Input Current LED) illuminates.

The normal operating battery voltage range is between 11 and 15 volts.

## Checking Output Power

During Inverter mode, you can check how much power (displayed in kW) the Freedom HF is supplying to the connected loads by pressing the Select button until the Output Power LED illuminates.

## Operating Several Loads at Once

If you are going to operate several loads from the Freedom HF, turn them on one at a time after you have turned the inverter on.

Turning loads on separately helps to ensure that the inverter does not have to deliver the starting current for all the loads at once, and will help prevent an overload shutdown.

## Turning the Audible Alarm ON or OFF

The Freedom HF's audible alarm can be turned ON or OFF. Any warnings such as fault conditions or imminent shutdown are both displayed on the display panel's screen and sounded on the alarm speakers.

It is not possible to turn OFF the screen and prevent it from displaying error codes but it is possible to turn OFF the audible alarm.

**NOTE:** The alarm setting will reset to its default setting when the Freedom HF's Inverter Power button is turned OFF then turned ON again.

## **Operating During Transition Between Shore Power and Inverter Mode**

The Freedom HF's advanced power management is capable of transitioning power from an AC source to DC source within a fraction of a second and vice-versa.

The Freedom HF automatically detects when shore power is present and when it becomes unavailable or drops to less than 90 volts AC.

## **Transitioning from Shore Power to Inverter Mode**

When the unit is operating in shore power mode and shore power is lost, the Freedom HF has less than 30 milliseconds to switch to inverter mode and start drawing power from the battery.

The Status LED will turn from solid or flashing GREEN to a solid YELLOW.

## **Transitioning from Inverter Mode to Shore Power**

When the unit is operating in inverter mode and shore power becomes available, the Freedom HF begins a 20-second countdown to verify the stability of the shore power. If shore power remains stable within 20 seconds, at the end of the countdown, the Freedom HF has less than 30 milliseconds to switch to shore power mode and start drawing power from the AC source.

The Status LED will turn from solid YELLOW to flashing YELLOW during the 20-second countdown, then turn to GREEN when battery power is transitioned successfully to shore power.

## Operating Limits Power Output

The Freedom HF can deliver up to 1000 watts (Freedom HF 1000 and 1055), 1500 watts (Freedom HF 1500), or 1800 watts (Freedom HF 1800) continuous power. The wattage rating applies to resistive loads such as incandescent lights.

## Input Voltage

### For all models

The allowable Freedom HF input voltage ranges are shown in the following table for all models<sup>a</sup> except Freedom HF 1500 and Freedom HF 1800 T:

Operating Condition	Voltage Range	Comment
Full Operating Range	Low: 10.5–15.5 volts High: 11.8–15.5 volts	Low refers to low limit of the low voltage threshold. High refers to high limit of the low voltage threshold.
Optimum Performance	12.0–13.0 volts	No comment
Low Voltage Alarm	Low: <11.0 volts High: <12.3 volts	The low battery alarm beeps once every two seconds and the display shows fault code E05.
Low Voltage Shutdown	Low: <10.5 volts High: <11.8 volts	The low battery alarm beeps every second and the display shows fault code E01. The status LED turns red and the display screen is turned OFF within 30 seconds to protect the battery from being over-discharged.
High Voltage Shutdown	15.5 volts or more	The over-voltage alarm beeps every second and the display shows fault code E02 alternating with the battery voltage. The status LED turns red and the display screen is turned OFF within 30 seconds to protect itself from excessive input voltage.  <b>NOTE:</b> Although the Freedom HF incorporates over-voltage protection, it can still be damaged if input voltage exceeds 16 volts.

a. Including some Freedom HF 1800 T (806-1840-01).

### For Freedom HF 1500 and Freedom HF 1800 T

The allowable Freedom HF input voltage ranges are shown in the following table for Freedom HF 1500 and Freedom HF 1800 T<sup>b</sup>:

Operating Condition	Voltage Range Freedom HF 1500 only	Voltage Range Freedom HF 1800 T only	Comment
Full Operating Range	Low, Mid, High: 12.1–15.5 volts	Low: 10.5–15.5 volts Mid: 11.8–15.5 volts High: 12.1–15.5 volts	Low refers to low limit of the low voltage threshold. Mid refers to middle limit of the low voltage threshold. High refers to high limit of the low voltage threshold.
Optimum Performance	12.1–13.0 volts	12.1–13.0 volts	No comment
Low Voltage Alarm	Low, Mid, High: <12.6 volts	Low: <11.0 volts Mid: <12.3 volts High: <12.6 volts	A silent low battery warning shows fault code E05 on the display.
Low Voltage Shutdown	Low, Mid, High: <12.1 volts	Low: <10.5 volts Mid: <11.8 volts High: <12.1 volts	A single one-second low battery alarm beeps and the display shows fault code E01. After five minutes, the unit shuts down completely.
Low Voltage Shutdown for model PN:806-1840-05 only	n/a	Low: <11.8 volts Mid: <12.1 volts High: <12.1 volts	A single one-second low battery alarm beeps and the display shows fault code E01. After five minutes, the unit shuts down completely. Low Voltage Recovery is as follows:  Low: 12.0 volts Mid: 12.3 volts High: 12.3 volts
Instant Low Voltage Shutdown	<10.2 volts	<10.2 volts	After two seconds below the limit, the unit shuts down and the low battery alarm sounds a long beep continuously for 30 seconds

Operating Condition	Voltage Range Freedom HF 1500 only	Voltage Range Freedom HF 1800 T only	Comment
High Voltage Shutdown	15.5 volts or more	15.5 volts or more	The over-voltage alarm beeps every second and the display shows fault code $E02$ alternating with the battery voltage. The status LED turns red and the display screen is turned OFF within 30 seconds to protect itself from excessive input voltage. <b>NOTE:</b> Although the Freedom HF incorporates over-voltage protection, it can still be damaged if input voltage exceeds 16 volts.

b. Excluding some Freedom HF 1800 T (806-1840-01).

## Inverter Loads

The Freedom HF will operate most AC loads within its power rating of 1000 watts (Freedom HF 1000), 1500 watts (Freedom HF 1500), or 1800 watts (Freedom HF 1800). However, some appliances and equipment may be difficult to operate, and other appliances may actually be damaged if you try to operate them with the Freedom HF. Please read *High Surge Loads on page 37* and *Trouble Loads on page 38* carefully.

## Overload Conditions

There are two kinds of overload conditions; overload warning and overload shutdown.

### Overload Warning

When the Freedom HF's AC load is approximately 100 W below the overload shutdown limit of ~1000 W (Freedom HF 1000) and ~1800 W (Freedom HF 1500/1800), the audible alarm beeps once every two seconds and the display screen shows a fault code  $E05$ .

### Overload Shutdown

When the Freedom HF's AC load increases to near ~1100 W (Freedom HF 1000 models) and ~2000 W (Freedom HF 1500/1800 models), the audible alarm beeps every second and the display screen shows a fault code  $E03$ . The Status LED turns solid RED and in 30 seconds, both the unit and the display screen will shut down to prevent damage to the inverter and protect the battery from being over-discharged.

## High Surge Loads

Some induction motors used in freezers, pumps, and other motor-operated equipment require high surge currents to start. The Freedom HF may not be able to start some of these motors even though their rated steady state current draw is within the inverter's limits. The unit will shut down and indicate an overload shutdown.

## Over-temperature Conditions

During Inverter mode, when the Freedom HF's internal temperature starts to approach its preset shutdown limit, the alarm will beep every two seconds and the display will show fault code *E07*. If the over-temperature condition persists, the alarm will beep once per second and the display will show fault code *E04*.

The Status LED turns solid RED and the inverter will shut down to prevent damage to the inverter and protect the battery from being over-discharged. However, when the internal temperature drops and falls within normal operating temperature, the Freedom HF will recover automatically and will continue inverting.

During AC shore power mode, when the Freedom HF's charger temperature starts to approach its limit, the charging current will be reduced to 10 amps (Freedom HF 1000 models) or 20 amps (Freedom HF 1500/1800 models).

The Freedom HF also monitors the internal transfer relay temperature. It automatically turns on the fan when the relay starts to approach its preset temperature limit and turns off when it cools down. If the relay exceeds its preset temperature limit, the display shows a fault code *E11*. See *"To reset error codes E10 to E12: "* on page 48.

## Trouble Loads

### **NOTICE**

#### **EQUIPMENT DAMAGE**

Some equipment may be damaged by the Freedom HF's modified sine wave output, which has a different wave form than utility-supplied electricity.

**Failure to follow these instructions can result in equipment damage.**

Some appliances, including the types listed below, may be damaged if they are connected to the Freedom HF:

- Speed controllers found in some fans, power tools, kitchen appliances, and other loads may be damaged.
- Some chargers for small rechargeable batteries can be damaged. See *Precautions When Using Rechargeable Appliances on page 9* for details.
- Metal halide arc (HMI) lights can be damaged.

**IMPORTANT:** If you are unsure about operating any device with the Freedom HF, contact the manufacturer of the device to ensure that it is compatible with the modified sine waveform.

## Battery Charging

Battery charging is possible only when shore power is present and the Freedom HF unit is connected to a battery (or battery bank).

The frequency of battery charging is determined by how much energy in the battery is used up during inverting. Whenever the Freedom HF detects a battery voltage that falls below 12.8 volts, the unit will begin charging the battery, i.e., enter into bulk and absorption stages then settle in float stage. If battery voltage does not reach 5 volts after one minute or 10 volts after 15 minutes as shown in the graph, the unit will terminate the charging process and the error code  $E 12$  will show on the display screen.

*Figure 16* illustrates the three-stage charging process used to maximize Freedom HF's charging efficiency.

Figure 16 Three-stage Charging Process

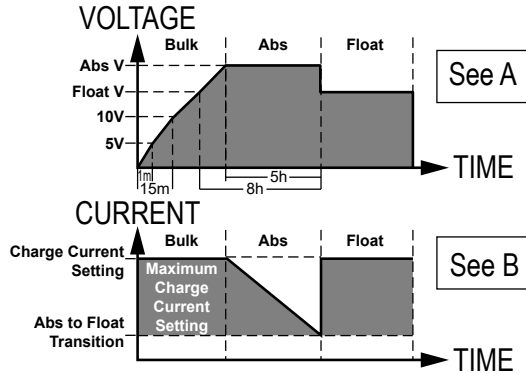

A	If an external DC load is connected to the battery and it drains the battery down to 12.8 Vdc, the charger will start a new bulk stage.
B	During the Float stage, the charger will provide up to the maximum set charge current to compensate for an external DC load on demand.

Table 3 Status LED during Inverter Mode

Status LED	Display Screen	Condition
Solid GREEN	FULL	Battery is FULL.
Flashing GREEN	$bUL - CH9 - 12.8$ (where 12.8 is an example of battery voltage)	Battery is in BULK CHARGE.
	$Ab5 - CH9 - 14.2$ (where 14.2 is an example of battery voltage)	Battery is in ABSORPTION CHARGE.
Solid RED	E 10 to E 12	See Error Code on page 46.

Table 4 illustrates the battery charging voltage and current settings for the Freedom HF 1000 model and all Freedom HF 1800 models.

Table 4 Battery Charging Voltage and Current Settings

Battery Type	Bulk/Absorption (Volts)	Float (Volts)	Charge Current (Amps)	Absorption to Float transition (Amps)
Flooded	14.4	13.5	2, 5 <sup>a</sup> , 10, 20, 40 <sup>b</sup>	2, 2 <sup>a</sup> , 5 <sup>a</sup>
GEL	14.2	13.8	2, 5 <sup>a</sup> , 10, 20, 40 <sup>b</sup>	2, 2 <sup>a</sup> , 5 <sup>b</sup>
AGM	14.3	13.4	2, 5 <sup>a</sup> , 10, 20, 40 <sup>b</sup>	2, 2 <sup>a</sup> , 5 <sup>b</sup>
Fixed	13.5	13.5	2, 5 <sup>a</sup> , 10, 20, 40 <sup>b</sup>	2, 5 <sup>a</sup> , 10, 20, 40 <sup>b</sup>

a. Applicable to Freedom HF 1000 models only.  
 b. Applicable to Freedom HF 1500/1800 models only.

Table 5 illustrates the battery charging voltage and current settings for the Freedom HF 1000 model and all Freedom HF 1800 models.

Table 5 Battery Charging Voltage and Current Settings

Battery Type	Bulk/Absorption (Volts)	Float (Volts)	Charge Current (Amps)	Absorption to Float transition (Amps)
Flooded	14.4	13.5	5, 15 35, 55	2 5
GEL	14.2	13.8	5, 15 35, 55	2 5
AGM	14.3	13.4	5, 15 35, 55	2 5
Fixed	13.5	13.5	5, 15 35, 55	2 5

## Routine Maintenance

### Freedom HF Unit

Minimal maintenance is required to keep your Freedom HF operating properly. Periodically you should:

Clean the exterior of the unit with a damp cloth to prevent the accumulation of dust and dirt.

Ensure that the DC cables are secure and fasteners are tight.

Make sure the ventilation openings are not clogged.

### Batteries

When possible, you should recharge your batteries whenever a low voltage warning or a shutdown occurs with the Freedom HF. This gives the batteries a much longer life than recharging when the batteries have been almost completely discharged.



# Inverter Overload Operation

This graph shows how long (measured in milliseconds) the Freedom HF will operate for a given output current (measured in Amps).

Both the Freedom HF 1000/1055 models and Freedom HF 1500/1800 models are represented in the illustration below.

The graph illustrates surge operation at 25 °C.

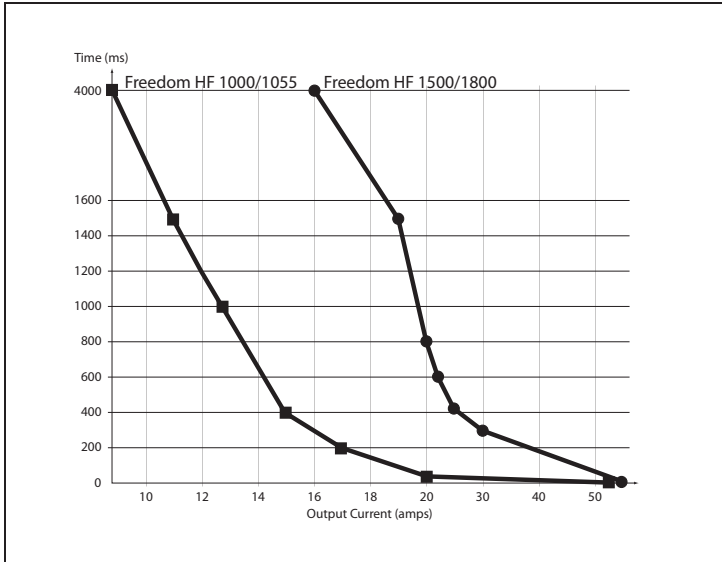

# Invert Power Derating vs. Ambient Temperature

If the unit is in inverter mode and in elevated ambient temperature above 25 °C, you will have to reduce power draw according to the following chart to avoid over-temperature shutdown.

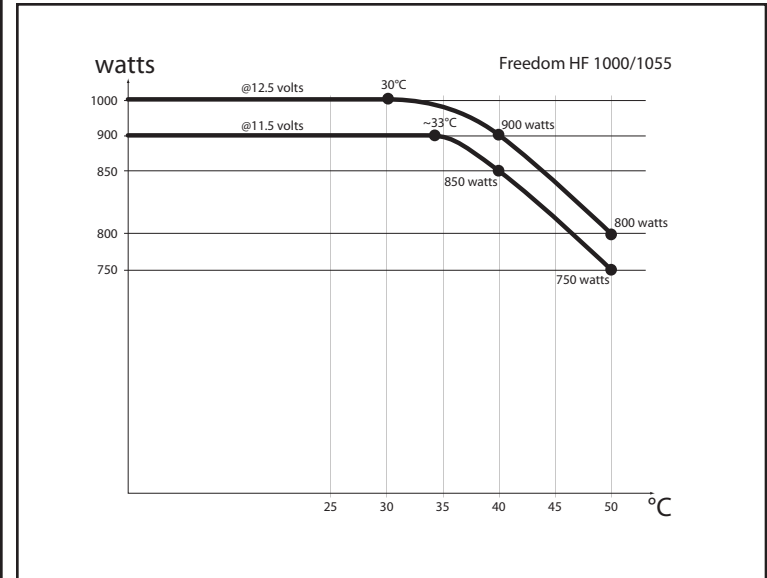

## Inverter Overload Operation

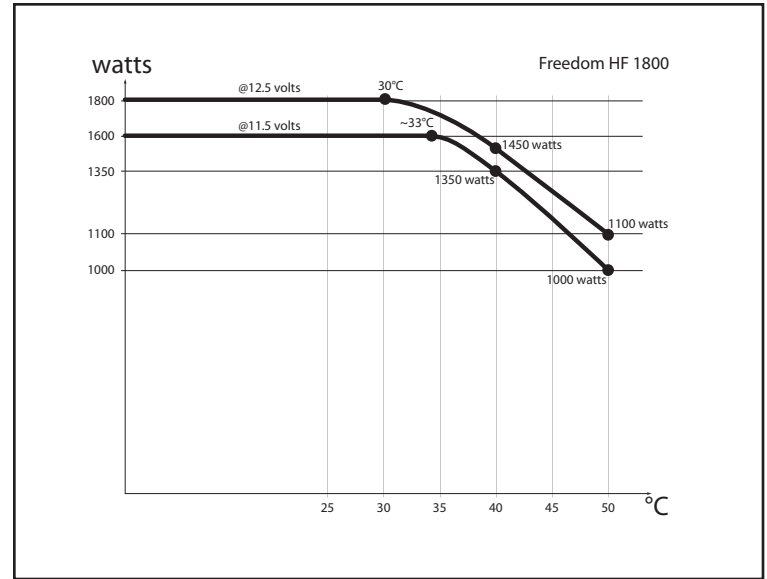
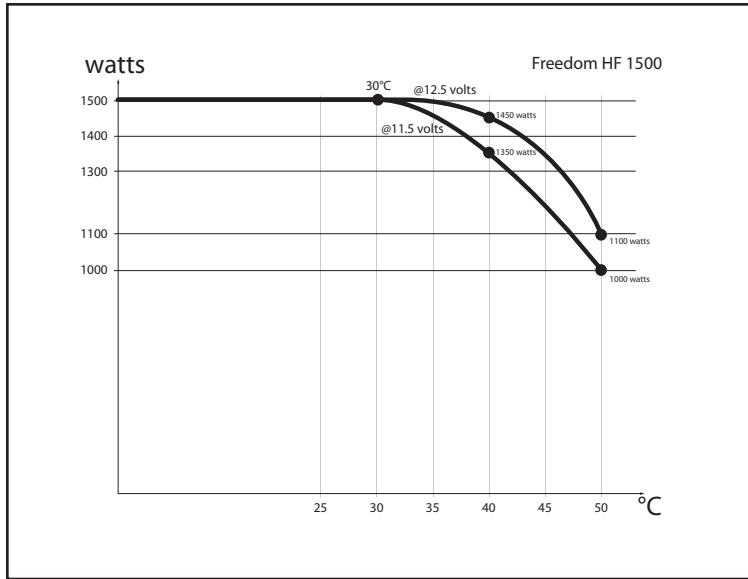

## 4 TROUBLESHOOTING

This section will help you narrow down the source of any problem you encounter.

### **WARNING**

#### **ELECTRICAL SHOCK HAZARD**

Do not disassemble the Freedom HF. It does not contain any user-serviceable parts. Attempting to service the unit yourself could result in an electrical shock or burn.

**Failure to follow these instructions can result in death, serious injury, or equipment damage.**

**NOTE:** To obtain service go to *Contact Information on page 2*. Before contacting customer service, please work through the steps listed below.

1. Check for any error codes displayed on the LCD screen. If a message is displayed, record it before doing anything further.
2. As soon as possible, record the conditions at the time the problem occurred so you can provide details when you contact customer service for help. Include the following information:
  - What load the Freedom HF was running or attempting to run
  - What the battery condition was at the time (voltage, etc.) if known
  - Recent sequence of events

- Any known unusual AC shore power factors such as low voltage, unstable generator output, etc.
  - Whether any extreme ambient conditions existed at the time (temperature, vibrations, moisture, etc.)
3. If your Freedom HF is not displaying an error code, check the following to make sure the present state of the installation allows proper operation:
    - Is the inverter/charger located in a clean, dry, adequately ventilated place?
    - Are the battery cables adequately sized as recommended in the Installation guide?
    - Is the battery in good condition?
    - Are all DC connections tight?
    - Are the AC input and output connections and wiring in good condition?
    - Are the configuration settings correct for your particular installation?
    - Are all disconnects and AC breakers closed and operable?
    - Have any of the fuses blown in the installation?
  4. Contact customer support for further assistance. Please be prepared to describe details of your system installation and to provide the model and serial number of the unit.

## Common Problems

### Buzz in Audio Equipment

Some inexpensive stereo systems may emit a buzzing noise from their loudspeakers when operated from the Freedom HF. This occurs because the power supply in the audio system does not adequately filter the modified sine wave produced by the inverter.

The only solution is to use a sound system that has a higher quality power supply.

### Television Reception

When the Freedom HF is operating, it can interfere with television reception on some channels. If interference occurs, try the following:

1. Make sure that the chassis ground stud on the Freedom HF is solidly connected to the ground system of your vehicle or vessel.
2. Make sure that the television antenna provides an adequate (“snow-free”) signal, and that you are using good quality cable between the antenna and the television.
3. Keep the cables between the battery and the Freedom HF as short as possible, and twist them together with two to three twists per foot. (This minimizes radiated interference from the cables.)
4. Move the television as far away from the Freedom HF as possible.
5. Do not operate high power loads with the Freedom HF while the television is on.

## Warning Messages

Warning messages in the form of audible alarms and error codes that appear on the LCD screen to alert you to an impending system change. Warnings do not affect operation.

With the exception of the error codes displayed on the screen, only the audible alarm can be turned ON or OFF. Follow the steps in *Turning the Audible Alarm ON or OFF on page 1* to change the alarm settings.

The error codes are listed in *Table 6*. The text in the **Error Code** column appears on the LCD screen of the display panel.

Table 6 Error codes displayed on the Display Panel screen

<b>Error Code</b>	<b>Condition</b>	<b>Mode</b>	<b>Action</b>
E01	Low battery voltage shutdown is imminent depending on the setting, see <i>Operating Limits</i> on page 35.	Inverting	Check battery status and recharge if necessary. Check for proper DC cable sizing. Check for loose connections and tighten if necessary.
E02	High battery voltage shutdown > 15.5 volts DC	Inverting	Check for external charging sources, such as a PV charger and an over voltage alternator. Disconnect, if necessary.
E03	AC output overload shutdown	Inverting	Reduce the loads connected to the AC outlet of the unit. Check appliances that have high-surge ratings and disconnect if necessary.
E04	Over-temperature shutdown	Inverting	Reduce the loads connected to the AC outlet of the unit. Check that the ventilation grille is not blocked. Check for ambient temperature and move the unit to a cooler location whenever possible.
E05	Low battery voltage detected depending on setting, see <i>Operating Limits</i> on page 35.	Inverting	Check battery status and recharge if necessary. Check for proper DC cable sizing. Check for loose connections and tighten if necessary.
E06	AC output overload warning	Inverting	Reduce the loads connected to the AC outlet of the unit.
E07	Over-temperature warning	Inverting	Reduce the loads connected to the AC outlet of the unit. Check that the ventilation grille is not blocked. Check for ambient temperature and move the unit to a cooler location whenever possible.
E08	not used		
E09	not used		

Error Code	Condition	Mode	Action
<i>E 10</i>	High battery voltage (> 15.5 V)	AC shore power	Check for external charging sources, such as an over voltage alternator, and disconnect if necessary. Confirm that the external charging source is not the cause. The error may be caused by the internal battery charger system. Call Xantrex for support.
<i>E 11</i>	Over-temperature detected on the AC transfer relay	AC shore power	Reduce the loads connected to the AC outlet of the unit. Check that the ventilation grille is not blocked. Check for ambient temperature and move the unit to a cooler location whenever possible.
<i>E 12</i>	Battery is bad or external DC load is connected to the battery.	AC shore power	Check the battery bank. NOTE: The battery voltage did not rise above 5 volts DC after 1 minute or 10 volts DC after 15 minutes.  Check that the external DC load current consumption is below the charging current setting. Disconnect the DC load or increase the charger current setting.

**For error code *E 01*:**

- the display screen and the alarm will turn off after 30 seconds<sup>a</sup>
- after a five-minute shutdown delay<sup>b</sup>, the unit will immediately stop inverting

**For error codes *E 02* to *E 04*:** the unit will stop inverting.

**For error code *E 12*:**

- the unit will stop charging and shut down, and
- the error code will show on the display screen briefly, and
- AC power will not pass through to the AC outlets.

<sup>a</sup>Available in all models (including some PN: 806-1840-01) except Freedom HF 1500 and 1800 T.

<sup>b</sup>Available only for the Freedom HF 1500 and 1800 T models.

### **For error codes E 10 to E 11:**

- the unit will stop charging, but
- the error code will still show on the display screen and the
- alarm will remain on, and
- AC power will continue to pass through to the AC outlets.

### **To reset error codes E 10 to E 12:**

1. Remove the AC input.
2. Turn the unit OFF and then turn ON again using the Inverter Power button on the display panel.



# Troubleshooting Reference

## **WARNING**

### **ELECTRICAL SHOCK HAZARD**

Do not disassemble the Freedom HF. It does not contain any user-serviceable parts. Attempting to service the unit yourself could result in an electrical shock or burn.

**Failure to follow these instructions can result in death, serious injury, or equipment damage.**

## ***NOTICE***

### **INVERTER/CHARGER DAMAGE**

Avoid continually overloading the inverter/charger and subjecting it to over temperature conditions. Although provided with integral protection against overloads continual overloading can damage the circuitry.

**Failure to follow these instructions can result in damage to the inverter/charger.**

*Table 7 Troubleshooting reference*

<b>Problem</b>	<b>Possible Cause</b>	<b>Solution</b>
Battery charging current is lower than the charging set point during bulk charge mode.	Ambient (environment) temperature is high.	Do not be alarmed, the unit is performing normally. The charging current automatically de-rates at high ambient temperature. Improve ventilation. Make sure the unit's ventilation openings are not blocked.
Alarm does not sound when an error is encountered.	Alarm is turned OFF.	Press and hold the Select button for two seconds to disable (or enable) the audible alarm. See <i>Turning the Audible Alarm ON or OFF on page 33</i> .
Low output voltage (96 volts AC–104 volts AC) during Inverter mode.	You are using a voltmeter that cannot accurately read the RMS voltage of a modified sine wave.	Use a true RMS reading voltmeter such as the Fluke 87.

Problem	Possible Cause	Solution
<p>No output voltage. The status LED is red.</p>	<p>AC shore power is not available or out of operating range and the inverter has shut down with the display screen showing one of the following error codes:</p>	
	<p>Low input voltage (fault code E01)</p>	<ul style="list-style-type: none"> <li>• Check the DC connections and the cable.</li> <li>• Recharge the battery.</li> </ul>
	<p>High input voltage (fault code E02)</p>	<ul style="list-style-type: none"> <li>• Verify the unit is connected to a 12V battery.</li> <li>• Check the voltage regulation of the external charging system (if any).</li> </ul>
	<p>Unit overload or AC output short circuit (fault code E03)</p>	<ul style="list-style-type: none"> <li>• Reduce the load. Make sure the load does not exceed the output rating.</li> </ul>
	<p>Thermal shutdown (fault code E04)</p>	<ul style="list-style-type: none"> <li>• Allow the unit to cool off.</li> <li>• Reduce the load if continuous operation is required.</li> <li>• Improve ventilation. Make sure the inverter's ventilation openings are not blocked.</li> </ul>
	<p>AC transfer relay has overheated (during shore power mode).</p>	<ul style="list-style-type: none"> <li>• Improve ventilation. Make sure the inverter's ventilation grille is not blocked.</li> <li>• Reduce the load.</li> </ul>
<p>No output voltage. The Status LED is green or yellow.</p>	<p>GFCI has tripped or 15A supplementary breaker has tripped.</p>	<p>Check load and reset the GFCI or supplementary breaker.</p>
	<p>Circuit breaker on the AC load panel or AC output disconnect has tripped.</p>	<p>Reset the circuit breaker or check the AC output disconnect circuits.</p>
	<p>Battery voltage is too low (depending on setting, see <i>Operating Limits on page 35</i>) to start inverting. Display screen may show DC voltage as 00.0.</p>	<p>Check DC connections and cable. Recharge battery.</p>

Problem	Possible Cause	Solution
No output voltage. The status LED is not lighting up.	AC shore power is not available or out of operating range and the inverter is OFF.	<ul style="list-style-type: none"> <li>• Check AC shore power.</li> <li>• Turn the inverter ON.</li> </ul>
	AC shore power is not available and the inverter is OFF due to a shutdown for more than 30 seconds.	<ul style="list-style-type: none"> <li>• Check AC shore power and battery voltage.</li> <li>• Turn the inverter ON and look at the display panel for any error code.</li> <li>• See <i>Error Code on page 46</i>.</li> </ul>
	The inverter's DC input polarity is reversed.	<p>The inverter was probably damaged due to the reverse polarity. This type of damage is NOT covered by the warranty.</p> <ul style="list-style-type: none"> <li>• Return the unit.</li> <li>• See <i>Warranty online</i> for information on returning the unit.</li> </ul>
No output voltage. The status LED is not lighting up.	The jumper wire on the power module panel connecting the "Ignition Control" and "Disabled" terminals is removed and there is no ignition signal present.	Ensure the jumper wire is installed if the ignition control feature is not in use. If the ignition control feature is in use, ensure the vehicle's ignition is on.
The fan turns on and off during AC shore power mode.	<ul style="list-style-type: none"> <li>• The battery is discharged and demands high current from the charger.</li> <li>• AC pass-through current is high.</li> </ul>	Do not be alarmed, the unit is performing normally.
The fan turns on and off during inverter mode.	The inverter is running continuously at high power.	Do not be alarmed, the unit is performing normally. The fan is activated automatically.
Unexpected AC output overload condition warning (E05) or shutdown (E03) even though loads are within rated limits.	Unit is subjected to sudden extreme vibration or constant moderate vibration.	<p>In the case of a sudden extreme vibration, the unit will perform normally when the vibration stops.</p> <p>In the case of a constant moderate vibration, the unit may display a warning or shutdown. In either case, you have to remove the unit and place it near a more stable location not subject to constant moderate vibration.</p>

## Inverter Applications

The Freedom HF performs differently depending on the AC loads connected to it. If you are having problems with any of your loads, read this section.

### Resistive Loads

These are the loads that the inverter/charger finds the simplest and most efficient to drive. Voltage and current are in phase (that is, in step with one another). Resistive loads usually generate heat in order to accomplish their tasks. Toasters, coffee pots, and incandescent lights are typical resistive loads. It is usually impractical to run larger resistive loads—such as electric stoves and water heaters—from an inverter due to their high current requirements. Even though the inverter/charger can most likely accommodate the load, the size of battery bank required would be impractical if the load is to be run for long periods.

### Motor Loads

Induction motors (that is, motors without brushes) require two to six times their running current on start up. The most demanding are those that start under load, for example, compressors and pumps. Of the capacitor start motors (typical in drill presses, band saws, etc.), the largest you can expect to run is ½ hp (the transfer relays are rated at 2 hp). Universal motors are generally easier to start. Since motor characteristics vary, only testing will determine whether a specific load can be started and how long it can be run.

If a motor fails to start within a few seconds or loses power after running for a time, it should be turned off. When the inverter/charger attempts to start a load that is greater than it can handle, it will turn itself off after a few seconds.

### Long Transfer Times

The Freedom HF may take a long time (~ 0.1–0.2 s) to transfer to Battery Mode when shore power is cut off while powering a motor load. Motor loads typically “freewheel” when power is removed (for example, a grinder) and causes a longer transfer time. The longer transition from shore power to inverter power may cause connected computers or other sensitive equipment to operate incorrectly. To avoid this effect, do not connect motor loads together with sensitive equipment to the inverter/charger for power.

# 5 SPECIFICATIONS

**NOTE:** Specifications are subject to change without prior notice.

Physical Specifications	1000 - watt Models	1500   1800 -watt Models
L × W × H	15.5" (393mm) × 9.5" (241mm) × 4.2" (106mm)	18" (457mm) × 9.5" (241mm) × 4.2" (106mm)
Net Weight	10 lbs (4.5 kg)	12.8 lbs (5.8 kg)
		<b>NOTE:</b> Excludes any external AC or DC wiring harnesses included on some models.

Environmental Specifications	1000 - watt Models	1500   1800 -watt Models
Ambient Temperature:		
Operating Temperature Range	0–40 °C -20–60 °C with output derated above 25 °C	
Storage Temperature Range	-40–70 °C	
Humidity: Operation/Storage	5–95% RH, non-condensing	

System Specifications	1000 - watt Models	1500   1800 -watt Models
Transfer relay rating	30A, 2.0hp	
Transfer time	<30ms (milliseconds)	
Transfer on bad voltage	90–100V for low AC and 130–140 for high AC	
Cooling	Fan, activated by any of the following: <ul style="list-style-type: none"> <li>• High internal temperature</li> <li>• High AC output power</li> </ul>	

**NOTE:** These specifications refer to inverter mode.

DC Input	1000 - watt Models	1500   1800 -watt Models
Operating voltage range for all models including some Freedom HF 1800 T (806-1840-01)	10.5–15.5 VDC (low limit) 11.8–15.5 VDC (high limit)	10.5–15.5 VDC (low limit) 11.8–15.5 VDC (high limit)
Operating voltage range for Freedom HF 1500 and Freedom HF 1800 T (806-1840-01, 806-1840-03, 806-1840-04, 806-1840-05)	n/a	10.5–15.5 VDC (low limit) 11.8–15.5 VDC (mid limit) 12.1–15.5 VDC (high limit)
Safe non-operating voltage range	0–16 VDC	0–16 VDC
Nominal voltage for all models	12.5 VDC	12.5 VDC
Nominal current at full load	100 ADC	180 ADC

AC Output	1000 - watt Models	1500   1800 -watt Models
Output voltage	115 VAC	115 VAC
Continuous power	1.0kW @ 25 °C	1.8kW @ 25 °C 1.5kW @ 25 °C (Freedom HF 1500 only)
Surge power	17 AAC (2kW for 200 ms)	30 AAC (3.6kW for 300 ms)
Max short-circuit current	55 AAC peak	55 AAC peak
Frequency	60 Hz	60 Hz

AC Output	1000 - watt Models	1500   1800 -watt Models
Wave shape	Modified Sine Wave	Modified Sine Wave
Power derating above 40 °C ambient temp	See <i>Invert Power Derating vs. Ambient Temperature on page 41</i> .	
Peak efficiency	≥ 87%	≥ 87%
Full load efficiency	≥ 80%	≥ 80%

Other	1000 - watt Models	1500   1800 -watt Models
No load input power (producing output voltage)	≤ 10W	≤ 10W
Off mode current draw	≤ 1mA	≤ 1mA

**NOTE:** These specifications refer to charger mode.

<b>AC Input</b>	<b>1000 - watt Models</b>	<b>1500   1800 -watt Models</b>
Operating voltage range for all models	90–130 VAC	90–130 VAC
Nominal current	5 AAC at 20 A charge, 120 VAC IN	10 AAC at 40 A charge, 120 VAC IN
Nominal frequency	60 Hz	60 Hz

<b>DC Output</b>	<b>1000 - watt Models</b>	<b>1500   1800 -watt Models</b>
Nominal voltage	12.0 VDC	12.0 VDC
Min battery voltage for charging	0.0 VDC	0.0 VDC
Max output voltage	14.4 VDC	14.4 VDC
Nominal output current	User selectable: 2A, 5A, 10A, 20A (Freedom HF 1000) 5A, 15A, 35A, 55A (Freedom HF 1055)	User selectable: 2A, 10A, 20A, 40A
Charger current derating	Charger current will automatically derate as internal temperature exceeds 80 °C.	Charger current will automatically derate as internal temperature exceeds 80 °C.
Efficiency at nominal output	≥ 75%	≥ 75%

<b>Other</b>	<b>1000 - watt Models</b>	<b>1500   1800 -watt Models</b>
No load input power (producing output voltage)	≤ 10W	≤ 10W
Off mode current draw	≤ 1mA	≤ 1mA

<b>Regulatory Approvals</b>	<b>1000 - watt Models</b>	<b>1500   1800 -watt Models</b>
	ETL approved to CSA 107.1, UL458, and UL458 Marine Supplement (drip shield with product number 808-9531 required).	





# xantrex™

A MISSION CRITICAL ELECTRONICS BRAND

Smart choice for power™

<http://www.xantrex.com/>

(Toll Free USA/Canada) +1 800 670 0707

(Outside USA/Canada) +1 408 987 6030

975-0390-01-01 Rev J

Printed in: